

Dreiphasen-Ringkernsparstelltransformatoren DSS



- Schutzgrad IP00
- Isolierstoffklasse B
- Umgebungstemperatur max. +45°C
- Prüfspannung Wicklung-Welle 4 kV ~
- Frequenz 50/60 Hz
- Nenneingangsspannung 3 x 400 VAC



Typ	Eingangsspannung	Ausgangsspannung	Ausgangsstrom	Ausführung
DSS 9010	3 x 400 VAC	3 x (< 1 – 400) VAC	1.0 A	A
DSS 9013	3 x 400 VAC	3 x (< 1 – 400) VAC	1.2 A	A
DSS 9020	3 x 400 VAC	3 x (< 1.5 – 400 / 430) VAC	2.0 A	A / C / D
DSS 9032	3 x 400 VAC	3 x (< 2.5 – 400 / 430) VAC	3.0 A	A / C / D
DSS 9040	3 x 400 VAC	3 x (< 2.5 – 400 / 430) VAC	4.0 A	A / C / D
DSS 9063	3 x 400 VAC	3 x (< 3.5 – 400 / 430) VAC	6.0 A	A / C / D
DSS 9080	3 x 400 VAC	3 x (< 3.5 – 400 / 430) VAC	8.0 A	C / D
DSS 9100	3 x 400 VAC	3 x (< 3.5 – 400 / 430) VAC	10.0 A	C / D
DSS 9180	3 x 400 VAC	3 x (< 4.5 – 400 / 430) VAC	18.0 A	C / D
DSS 9200	3 x 400 VAC	3 x (< 4.5 – 400 / 430) VAC	20.0 A	C / D
DSS 9250	3 x 400 VAC	3 x (< 4.5 – 400 / 430) VAC	25.0 A	C / D
DSS 9320	3 x 400 VAC	3 x (< 4.5 – 400 / 430) VAC	32.0 A	D
DSS 9350	3 x 400 VAC	3 x (< 4.5 – 400 / 430) VAC	35.0 A	D
DSS 9420	3 x 400 VAC	3 x (< 4.5 – 400 / 430) VAC	42.0 A	D
DSS 9500	3 x 400 VAC	3 x (< 4.5 – 400 / 430) VAC	50.0 A	D
DSS 9630	3 x 400 VAC	3 x (< 4.5 – 400 / 430) VAC	63.0 A	D

Ausführung A / Dreieckskonstruktion

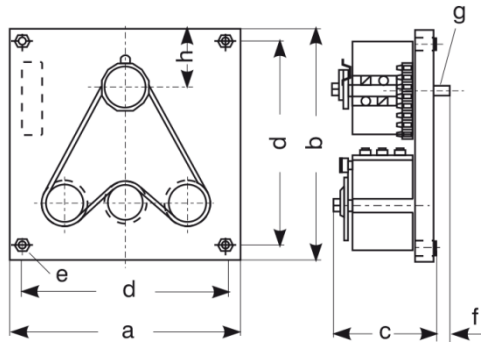

Typ	a (mm)	b (mm)	c (mm)	d (mm)	e	f (mm)	g ∅ (mm)	h (mm)	Gewicht (kg)
DSS 9010	200	200	80	180	M 5	0-20	6	53	5.5
DSS 9013	200	200	80	180	M 5	0-20	6	53	5.5
DSS 9020	300	300	100	260	M 5	0-20	8	75	10.0
DSS 9032	300	300	100	260	M 5	0-20	8	75	10.3
DSS 9040	300	300	100	260	M 5	0-20	8	75	14.0
DSS 9063	300	300	130	260	M 5	0-20	8	75	18.0

Ausführung C / Säulenkonstruktion, liegend für Frontmontage

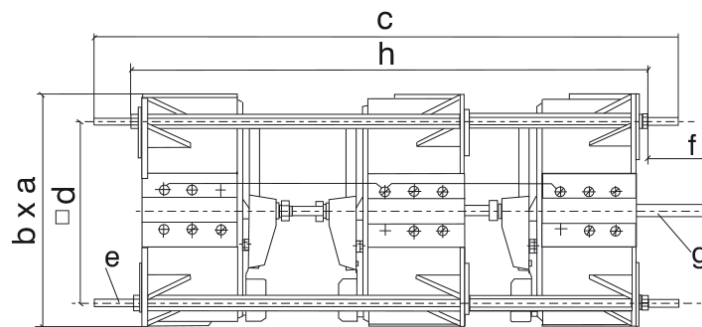

Typ	a (mm)	b (mm)	c (mm)	d (mm)	e	f (mm)	g ∅ (mm)	h (mm)	Gewicht (kg)
DSS 9020	137	125	315	96	M 5	0 - 40	8	285	10
DSS 9032	160	147	315	112	M 5	0 - 40	8	285	14
DSS 9040	160	147	315	112	M 5	0 - 40	8	285	14
DSS 9063	160	147	370	112	M 5	0 - 40	8	340	18
DSS 9080	198	185	406	142	M 6	0 - 40	8	380	28
DSS 9100	198	185	406	142	M 6	0 - 40	8	380	28
DSS 9180	244	231	445	180	M 10	0 - 40	8	403	48
DSS 9200	244	231	466	180	M 10	0 - 40	8	445	55
DSS 9250	244	231	466	180	M 10	0 - 40	8	445	55

Ausführung D / Säulenkonstruktion, stehend oder liegend

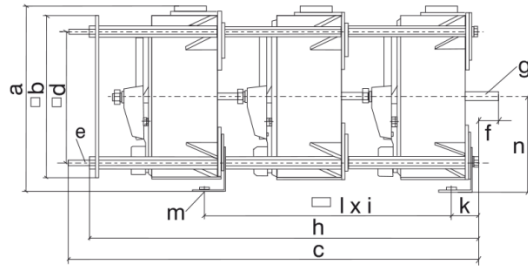

Typ	a (mm)	b (mm)	c (mm)	d (mm)	e	f (mm)	g ∅ (mm)	h (mm)	l x i (mm)	k (mm)	m	n (mm)	Gewicht (kg)
DSS 9020	144	125	321	96	M 5	35	8	303	195 x 102	21	M 5	70	11
DSS 9032	162	147	321	112	M 5	35	8	303	195 x 124	21	M 5	78	15
DSS 9040	162	147	321	112	M 5	35	8	303	195 x 124	21	M 5	78	15
DSS 9063	162	147	381	112	M 5	35	8	401	235 x 124	21	M 5	78	19
DSS 9080	205	185	418	142	M 6	35	8	401	259 x 162	22	M 6	101	29
DSS 9100	205	185	418	142	M 6	35	8	401	259 x 162	22	M 6	101	29
DSS 9180	253	231	444	180	M 10	35	8	422	270 x 210	26	M 8	126	49
DSS 9200	253	231	444	180	M 10	35	8	422	270 x 210	26	M 8	126	49
DSS 9250	253	231	498	180	M 10	35	8	475	300 x 210	26	M 8	126	56

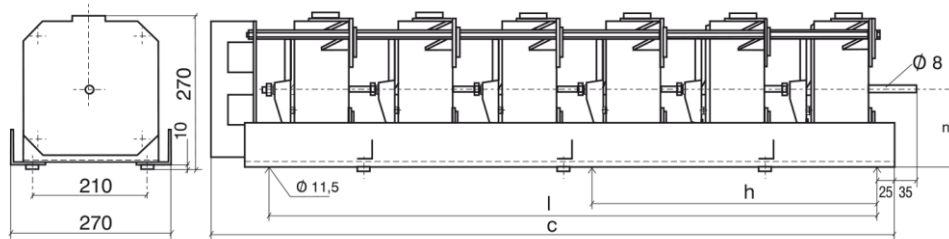

(Parallelschaltung von je 2 Einzeltransformatoren pro Phase)

Typ	c (mm)	h (mm)	l (mm)	n (mm)	Gewicht (kg)
DSS 9340	1275	470	850	132	106
DSS 9380	1275	470	850	132	106
DSS 9480	1365	520	950	132	120

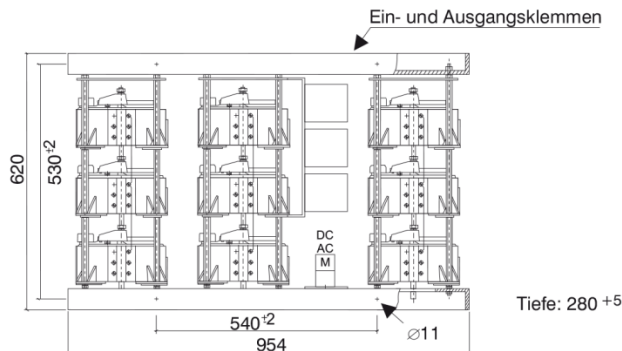

(Parallelschaltung von je 3 Einzeltransformatoren pro Phase)

Typ	Gewicht
DSS 9570	180
DSS 9720	200

Schaltbilder

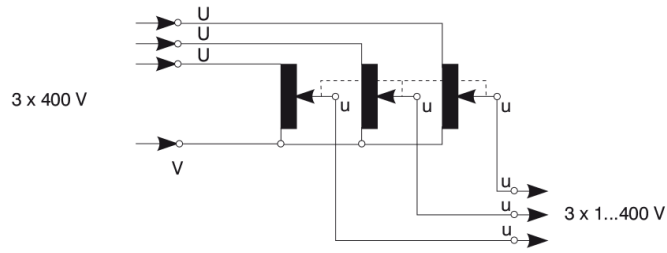

DSS 9010 A, DSS 9013 A

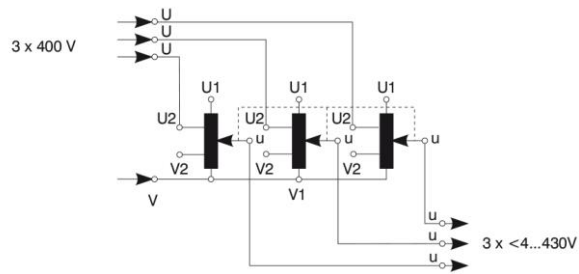

DSS 9020 A – DSS 9063 A
DSS 9020 D – DSS 9720 D

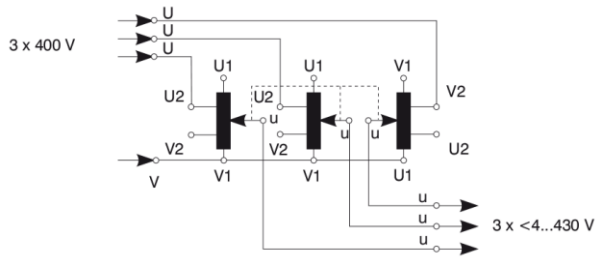

DSS 9020 C – DSS 9250 C